



**Bodenlaufschiene U-Profil**, Länge 3 m, Schraubmontage, Auslieferung ohne Befestigungsschrauben

Art. Nr.	B x H	Material	Material	kg
96 41 61	55 x 16	3	verzinkt	4,8
83 09 42	55 x 16	2	Edelstahl 1.4301	4,8



**Bodenlaufschiene U-Profil**, Länge 3 m, zum Einbetonieren

Art. Nr.	B x H	Material	Material	kg
96 41 60	55 x 55	4	verzinkt	14,0
83 09 43	65 x 52	2	Edelstahl 1.4301	14,0

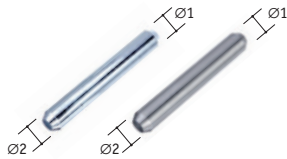

**Verbindungsstift U-Profil** für Bodenlaufschiene

Art. Nr.	Material	passend zu	Ø 1	Ø 2
96 41 49	verzinkt	96 41 61	12	12
83 08 99	V2A	83 09 42	12,5	12,5

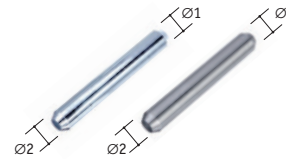

**Verbindungsstift U-Profil** für Bodenlaufschiene

Art. Nr.	Material	passend zu	Ø 1	Ø 2
96 41 79	verzinkt	96 41 60	11	11,5
83 08 76	V2A	83 09 43	14	14,5



**Schiebetorrolle U-Profil**

Art. Nr.	Ø
96 43 23	40
96 43 24	50



**Schiebetorrolle U-Profil**, mit 2 Kugellager

Art. Nr.	Ø
96 40 81	100
96 40 82	120

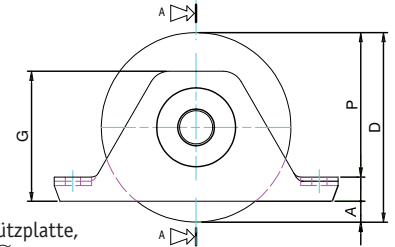
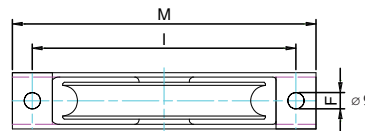
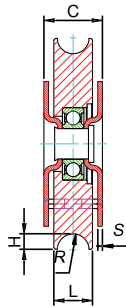
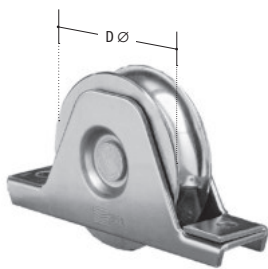

**Torrolle U-Profil**, mit Anschraubplatte, Kugellager und Stützplatte, innenliegend, verzinkt, Form U, Befestigungsbohrungen: Ø 9 mm

Art. Nr.	A	C	D Ø	F Ø	G	I	L	H	M	P	R	S	Material	Tragkraft kg	kg
96 41 58	8,5	32	88	9	70	130	24	9,5	155	65	10,5	3	verzinkt	190	1,03
83 07 48	8,5	32	88	9	70	130	24	9,5	155	65	10,5	3	V2A	190	1,08
96 41 67	13,5	32	98	9	70	130	24	9,5	155	70	10,5	3	verzinkt	200	1,26
83 07 49	13,5	32	98	9	70	130	24	9,5	155	70	10,5	3	V2A	200	1,3
96 41 50	16,5	37	117	9	80	155	25	9,5	185	85	10,5	3	verzinkt	220	2,3
83 07 50	16,5	37	117	9	80	155	25	9,5	185	85	10,5	3	V2A	220	2,02

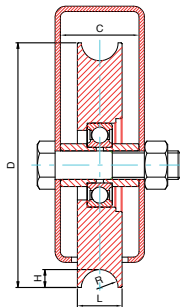
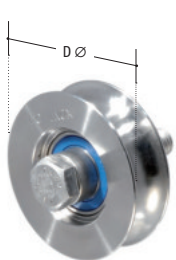

**Laufrolle U-Profil**, Laufrolle mit Kugellager, Form U, Bolzen M14 x 70

Art. Nr.	D Ø	C	L	H	R	Bolzen	Material	Tragkraft kg	kg
96 41 59	78	34	24	9,5	10,3	M14 x70	verzinkt	200	0,64
83 07 47	78	34	24	9,5	10,3	M14 x70	V2A	200	0,64
96 41 51	88	34	24	9,5	10,3	M14 x70	verzinkt	210	0,95
83 09 40	88	34	24	9,5	10,3	M14 x70	V2A	210	0,95
96 41 52	117	37	25	9,5	10,3	M14 x70	verzinkt	240	2,1
83 09 41	117	37	25	9,5	10,3	M14 x70	V2A	240	2,1

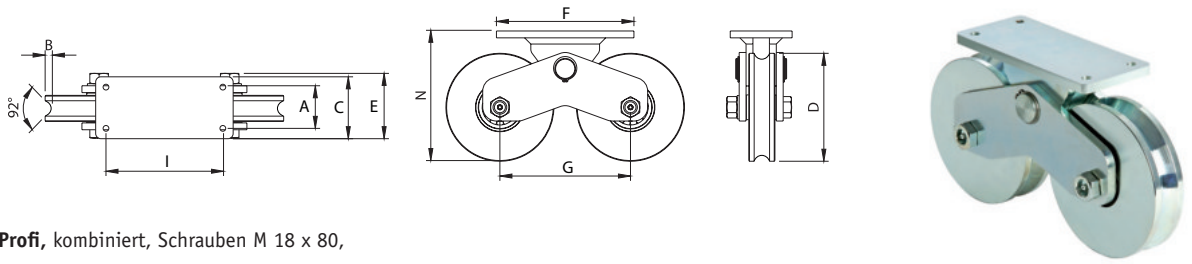

**Schiebetorrolle U-Profil, kombiniert, Schrauben M 18 x 80, mit 4 Kugellagern**

Art. Nr.	max. Belastung	A	B	C	D Ø	E	F	G	I	N	R	kg
<b>96 40 36</b>	1200 kg	62	9,56	90	117	95	200	190	171	170	10,5	20,0

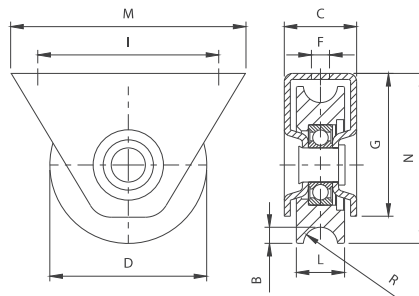

**Schiebetorrolle U-Profil, mit Außenstützplatte, mit 1 Kugellager**

Art. Nr.	max. Belastung	B	C	D Ø	F Ø	G	I	L	M	N	R	kg
<b>96 40 37</b>	200 kg	9,5	36	78	9	71	90	24	117	84,5	10,3	5,5

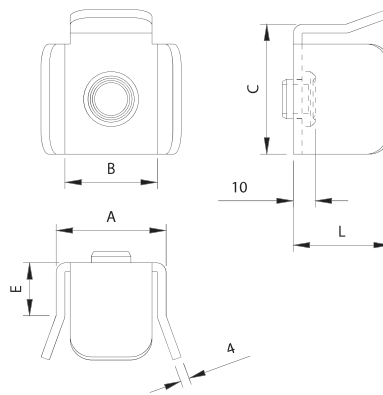

**Oberer Auflaufschuh, mit Schlusdämpfer**

Art. Nr.	Größe	A	B	C	E	L	kg
<b>96 40 90</b>	klein	50	42	59	24	45	1,6
<b>96 40 91</b>	mittel	60	52	69	30	50	2,3
<b>96 40 92</b>	groß	70	62	79	35	60	3,0

**V-Profil-Elemente**



**Bodenlaufschiene V-Profil, verzinkt, Länge: 3000mm**

Art. Nr.  
**96 40 79**



**Verbindungsstift, für Bodenlaufschiene V-Profil**

Art. Nr.  
**96 40 80**



**Schiebetorrolle V-Profil**

Art. Nr.	Ø
<b>96 43 20</b>	90
<b>96 43 21</b>	100
<b>96 43 22</b>	120